

version .0

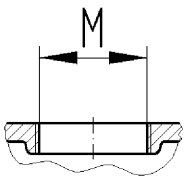

version .1

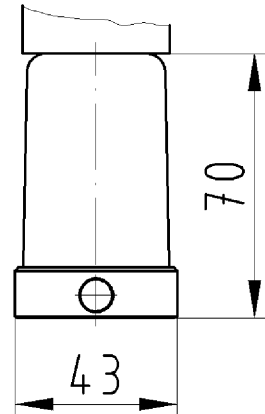
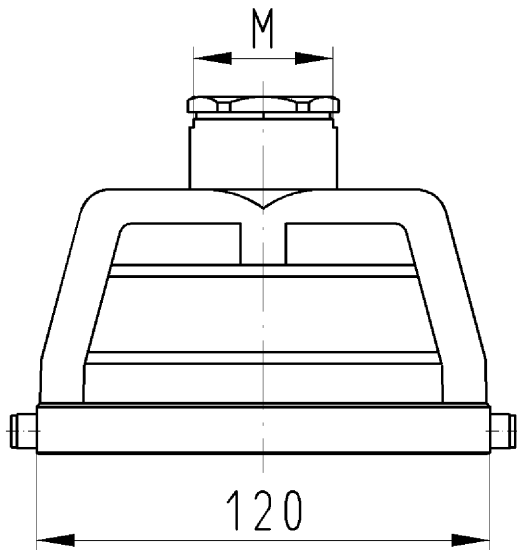
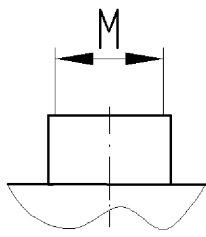

version .2

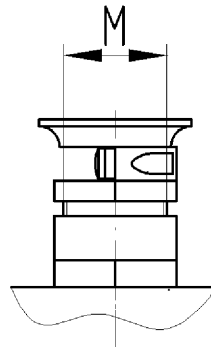

version .3

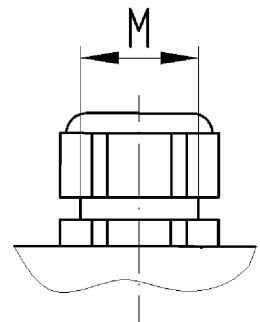

version .5

IP 65

Gehäuseoberteil
71.352.2435.0

Zeichnungsnummer
71.352.2435.010W
Gehäuseoberteil

03.12.2007
Hoffmann Angelika
M 1:2